

## Overview

Telergy™ is a powerful suite of software applications that offer centralized system management and comprehensive reporting. All applications share data in a common interface and use information drawn continuously from facility databases.

The Telergy interface represents a single integrated platform for communicating with wireless devices, generating management reports, and providing a wide range of valuable features, tools, and utilities.

The ESM Host receives data from the patient-staff communication system and forwards it to the appropriate Telergy application, which responds accordingly. All computers running Telergy are installed on a single network. In Telligence systems, a PowerSwitch forwards data to the Telligence Bridge, which forwards it to the ESM Host computer. In ProCare 6000 systems, a file server sends data to the ProCare 6000 Bridge, which in turn forwards it to the Event Subscription Manager (ESM) Host computer.

Telergy applications run inside the GE Application Player, which is an application frame that provides a set of uniform controls used by Telergy applications. This common configuration ensures that all Telergy applications remain intuitive and easy to use whether providing critical information in the midst of a crisis, or reporting activity for routine administrative tasks.

## Standard Features

Components of the Telergy suite of software applications include...

- **Mobility Suite™** delivers wireless system connectivity plus PC Assignments and PC Messaging, for a convenient all-in-one solution.
- **PC Assignments™** provides easy assignment of staff, wireless devices, and patient beds so patient calls are automatically delivered to the right caregivers.
- **PC Messaging™** provides convenient text messaging to mobile devices like pagers, wireless telephones and Vocera™ pendants.
- **MapView™ and ListView™** provide convenient graphical and list-based details concerning system activity.
- **ADT Bridge™** allows the user to import the hospital's HL7 admission, discharge and transfer (ADT) patient information to the SQL database for display with Telligence applications.
- **PC Reporting™** measures response times to patient calls and other system activity, and can even schedule reports for automatic email delivery.
- **NetBoard™** is an electronic whiteboard that displays real-time staff and patient information.

# Telergy

Patient-staff communications  
software suite

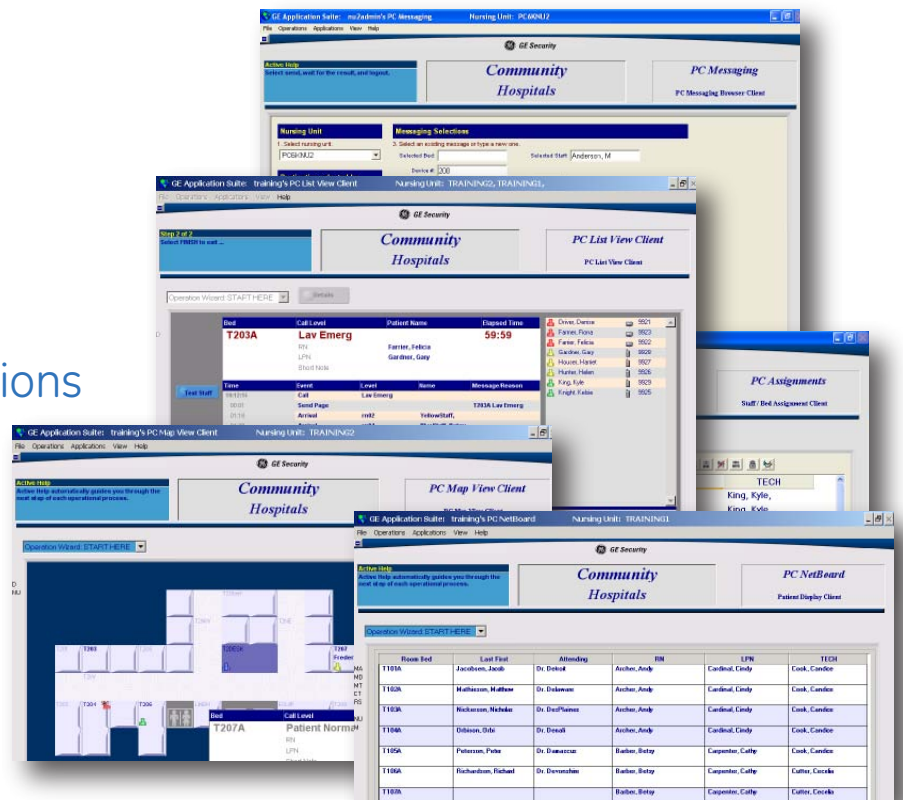

# Typical computer setup

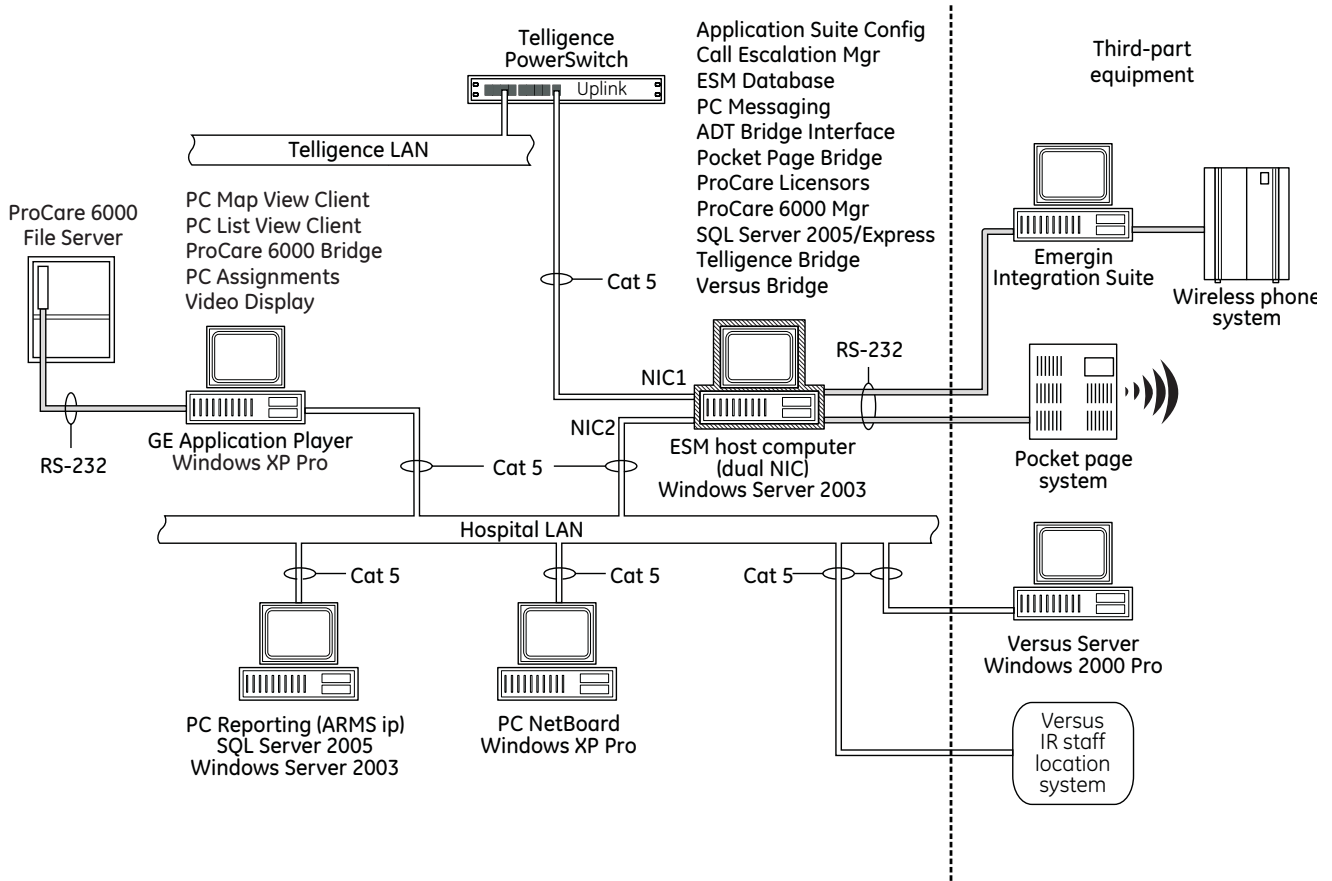

# Data flow between ESM Host and Telergy applications

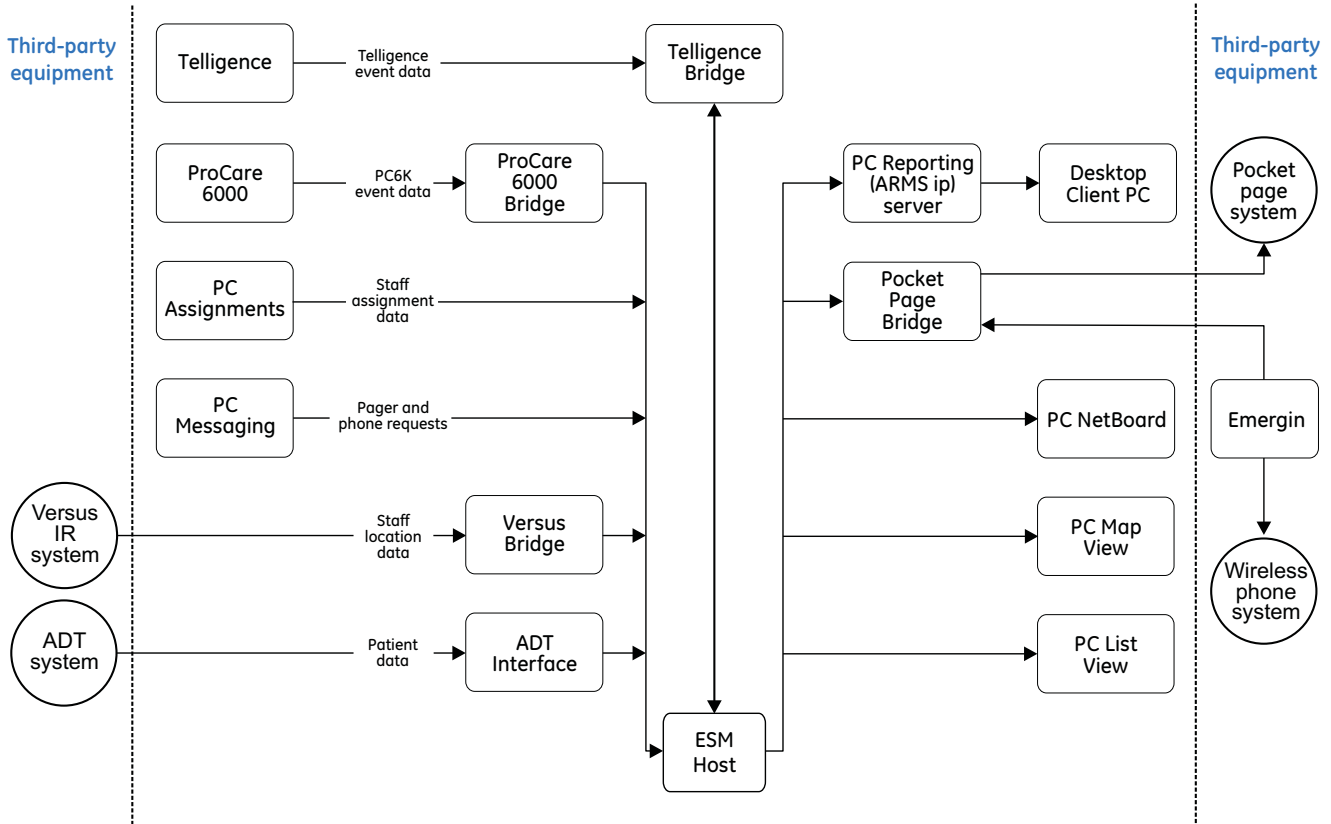

## PC Assignments

PC Assignment provides an easy way to automatically relay patient calls via text message directly to the appropriate caregiver's wireless device such as their pocket pager, wireless telephone, or Vocera badge.

An intuitive step-by-step wizard quickly establishes relationships for up to three levels of caregiver (e.g.: RN, LPN, AIDE) per patient bed, as well as Teams and Charge Nurse responsibilities. In fact, different types of calls can be easily routed to different caregiver levels according to specific needs and staff deployment, while any unanswered calls automatically roll over to the next staff level.

PC Assignments enhances and automates patient-staff communications so patient requests are delivered directly to the person best equipped to respond. Patient satisfaction increases because staff responds more quickly and delivers personal attention.

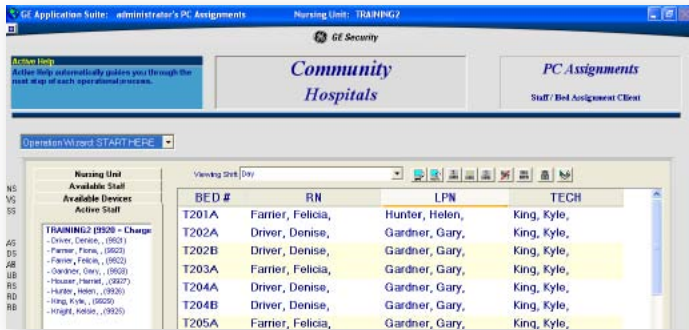

PC Assignments: Active Staff View

PC Assignments is compatible with ProCare 6000 and Telligence systems. It can operate on multiple computers simultaneously, depending on the number of licenses purchased.

Bed and device assignments allocated by PC Assignments are used by other Tellergy applications such as ListView and MapView. These software modules display information about active calls, as well as text-based paging messages generated by PC Assignments. In addition to routing unanswered calls to alternate caregivers, PC Assignments' data is displayed on a PC workstation.

## MapView

Map View uses a floor plan to show where activity is occurring in the unit. The application runs on a PC workstation, and can track patient calls, staff emergency calls, reminders, the status of linked equipment, and (where infrared staff location tracking functionality is installed) the locations of staff members. The application uses flashing colored squares to show the rooms from which the calls are sent. A convenient touchscreen or mouse user-interface makes screen navigation a snap.

Some of the data points available in MapView include:

- Patient Call Information
- Staff Location
- Patient Notes
- Reminders & Reminder Reasons
- Patient Room Call History
- Wireless Device Assignments
- Patient ADT information (with ADT interface)
- Messaging History
- Staff Assignments
- Patient Census (Room List)

## ListView

List View displays a prioritized list of patient-staff communications activity in the unit. List View runs on a PC workstation. The application can track patient calls, staff emergency calls, reminders, and the status of linked equipment. If staff location tracking is installed, the application also shows the locations of staff.



List View: Events Screen

A convenient touchscreen or mouse user-interface makes screen navigation quick and easy. The following data points are available in the ListView PC Console:

- Patient Call Information
- Staff Location
- Patient Notes
- Reminders & Reminder Reasons
- Patient Room Call History
- Wireless Device Assignments
- Patient ADT Demographics (with ADT interface)
- Messaging History
- Staff Assignments
- Patient Census (Room List)

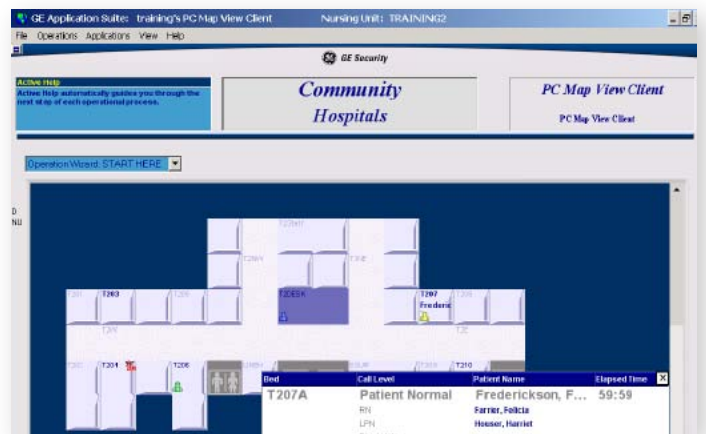

MapView: Call Detail

## PC Messaging

GE's browser-based PC Messaging application delivers the power of wireless messaging to any PC workstation on the hospital network. With PC Messaging any PC in the building can send a message to a pager or wireless phone or Vocera badge.

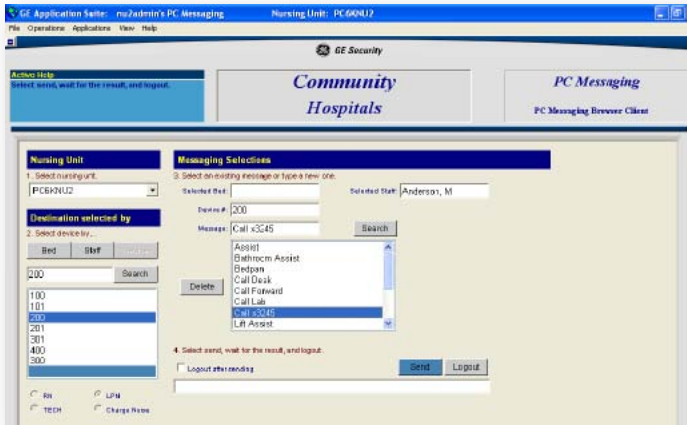

PC Messaging: Staff and Text Selection

Because assignments are set up on the nursing units via GE's PC Assignment client, PC Messaging accesses this same database and makes the information available to anyone wishing to send a message. All the sender needs to know is the wireless device number, room number (or patient name if interfaced with ADT), or staff name – any one of these will get the information to the correct caregiver or staff member.

## NetBoard

GE's PC NetBoard gathers and displays patient and staff information in a convenient user-defined screen. Some examples include:

- Patient Name
- Staff Assignments
- Attending Physician
- Room Status
- Patient Call Information
- Staff Presence
- Wireless Device Assignments
- Room-Specific Notes
- Patient-Specific Notes

PC NetBoard is a computer-based white board that provides nursing staff with up-to-the-minute patient information in a single application window. By default, all information is drawn directly from hospital databases and is updated continuously. For example, patient information and census data is retrieved directly from the hospital's Admit-Discharge-Transfer (ADT) database.

## PC Reporting

GE's PC Reporting software is built on a robust SQL database that captures virtually every event that occurs within connected patient-staff communications systems. These events include all patient calls, call answers, call reminders, staff arrivals and departures (if using staff presence indicators), intercom conversation starts and stops, and more. This data gives the caregiving team valuable insight into how well patient calls are being answered and how improvements might be made.

- Date and time
- Shift
- Nursing unit, (area) , room, and bed
- Patient name (if using ADT interface)
- Call types (e.g. Normal, Lavatory, Code, etc.)
- Quantity of calls
- Average and maximum response times
- Percent of calls within target response time

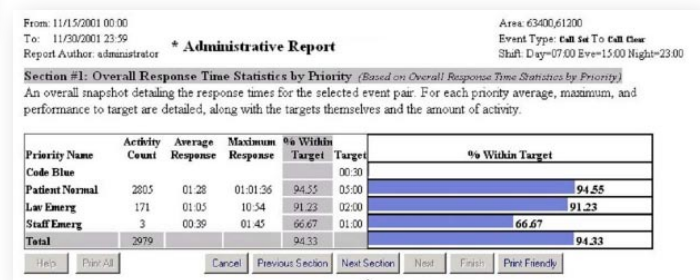

PC Reporting: Administrative Report

PC Reporting offers several predefined report formats that can be customized to meet the facility's specific requirements.



NetBoard: Patient Information Screen

Nursing assignments and related caregiver information are retrieved from PC Assignments and ProCare 6000 or Telligence.

PC NetBoard can be used in either ProCare 6000 or Telligence systems, and can be run on ProCare 6000 video displays and network computers.

## Mobility Suite

The Mobility Suite is a subset of Telergy that provides the core functionality needed for caregivers to be more mobile. This includes wireless phones, pagers, staff assignments, and text messaging.

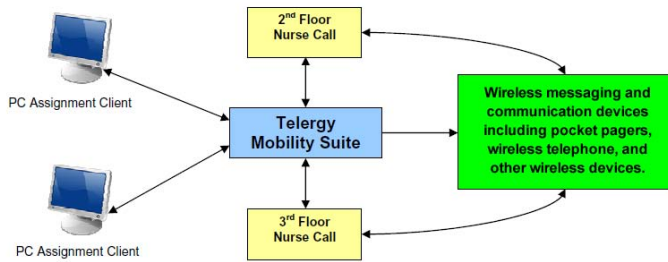

### Mobility Suite: Messaging

Mobility Suite comes with the ESM host application, Telligence Service, Pocket Page Bridge, PC Assignments, PC Messaging, and a Versus IR Location Bridge.

Either Mobility Suite or Mobility Suite Lite must be purchased with each Telergy installation. *Mobility Suite* includes 25 PC Assignments logins and 50 PC Messaging logins. *Mobility Suite Light* includes one PC Assignments login and one PC Messaging login. Other applications are optional.

## Admit/Discharge/Transfer (ADT) Interface

The ADT Interface is an add-on to the Mobility Suite and/or PC Reporting. It is required when the facility wishes to display patient information from its ADT system in Telergy applications such as PC Reporting, PC NetBoard, PC Assignments, and PC Messaging.

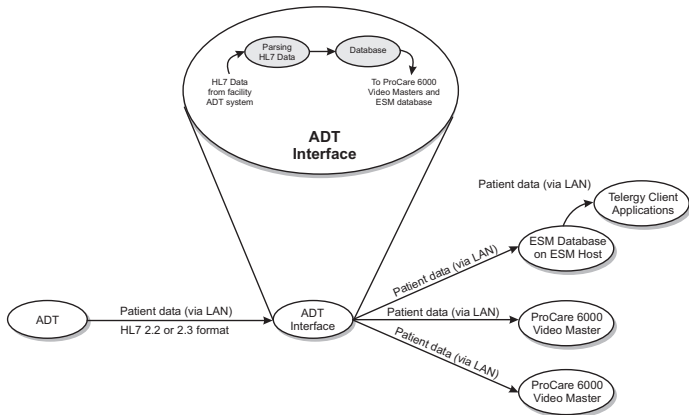

### ADT Interface Data Flow

## GE Application Player

The GE Application Player is an application frame that provides a set of uniform controls used by Telergy applications. This includes a menu bar, buttons for switching applications and for starting and performing tasks, a dynamic help window, and a wizard that helps perform user tasks. These screen elements operate in a similar way in all applications running in the player.

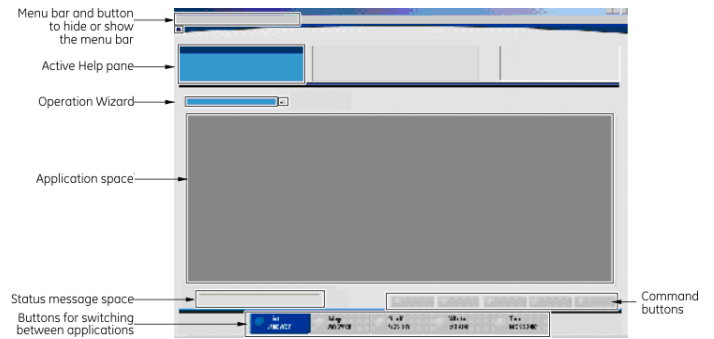

### GE Application Player Layout

U.S.  
T 800-385-2639  
F 800-800-5268

Canada  
T 519-748-5352  
F 519-748-9221

[www.gesecurity.com/sac](http://www.gesecurity.com/sac)

© 2007 General Electric Company  
All Rights Reserved

*Telligence*, *ProCare* and *Telergy* are  
trademarks of GE Security.

## More Information...

To learn more about Telergy, please consult  
the following publications:

### Guides

- *Telergy Planning Guide*, P/N 3101215
- *ADT Interface Requirements Guide*, P/N 3101247
- *PC Map and List View User Guide*, P/N 3101255
- *PC NetBoard User Guide*, P/N 3101143
- *PC Messaging User Guide*, P/N 3101156
- *PC Assignments User Guide*, P/N 3101154

